

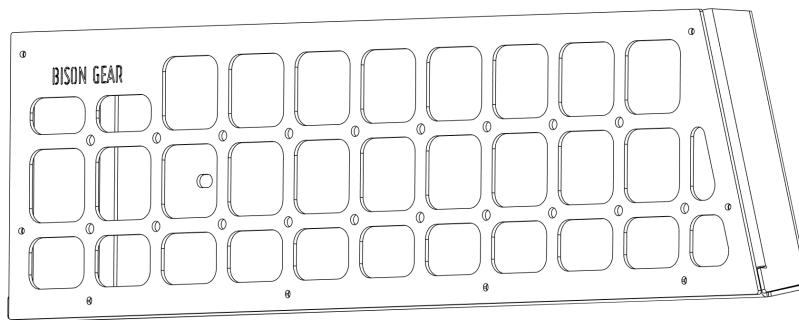

**BISON GEAR**

# INEOS Grenadier Cargo Basket Installation Guide

**BOX-GRND-LEFT, BOX-GRND-RIGHT**

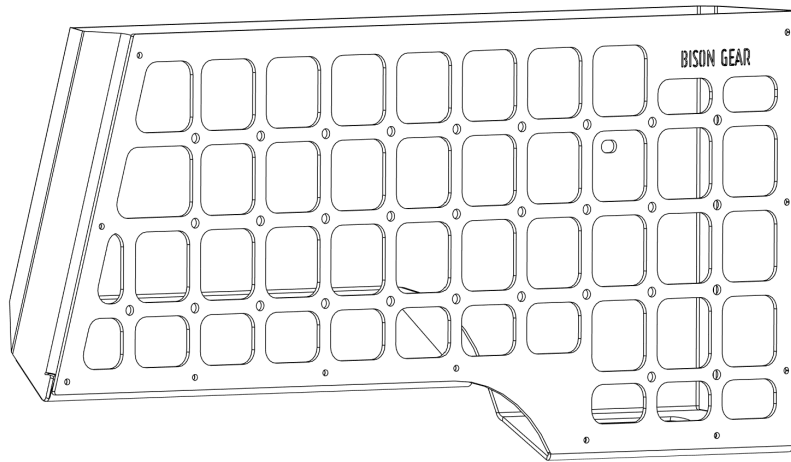





**BISON GEAR**

## Before you start

Familiarize yourself with this instruction. Instruction valid for both basket (left and right). The Cargo Basket is shipped with one package. Ensure that all listed parts and hardware are present in package. Gather the required tools.

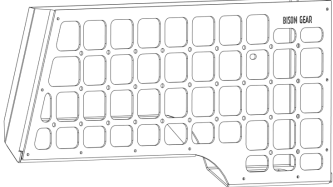
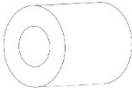
## Part list – Right basket

LP	PART	QTY	IMAGE
1	Right Basket	1	
2	Sleeve 10/20 H-25	2	
3	Bolt M8x60 ISO 7380-2	2	

## List of necessary tools:



- 5 mm Allen Key (Hex)<sup>1</sup>

<sup>1</sup> The tools **are not** included in the set.

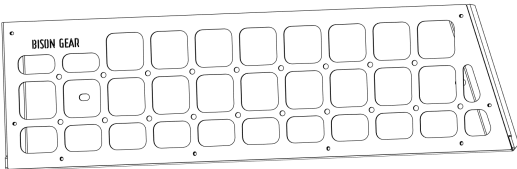
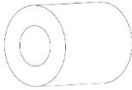

**BISON GEAR**

## Part list – Left basket

LP	PART	QTY	IMAGE
1	Left Basket	1	
2	Sleeve 10/20 H-25	2	
3	Bolt M8x60 ISO 7380-2	2	

## List of necessary tools:

- 5 mm Allen Key (Hex)<sup>2</sup>

<sup>2</sup> The tools **are not** included in the set.



**BISON GEAR**

## Installation:

Before you start installing baskets (left or right) you must dismount factory brackets – two brackets on the right side for the right basket, two brackets on the left side for the left basket.

Familiarize yourself with *Right Basket Diagram* (**page 5**) or *Left Basket Diagram* (**page 6**).

Put the Cargo Basket on its place and screw **all the bolts**.

Make sure that everything is mounted properly, and all the bolts are tightened. If it everything is correct, your work is done.

**After driving 50 km with your cargo basket, check all the bolts and re-tighten them if necessary.**

**Have great time with the Bison Gear products!**



Email: [contact@bison-gear.com](mailto:contact@bison-gear.com)

Phone: **+48 505 642 981**



**BISON GEAR**

## Right Basket Diagram

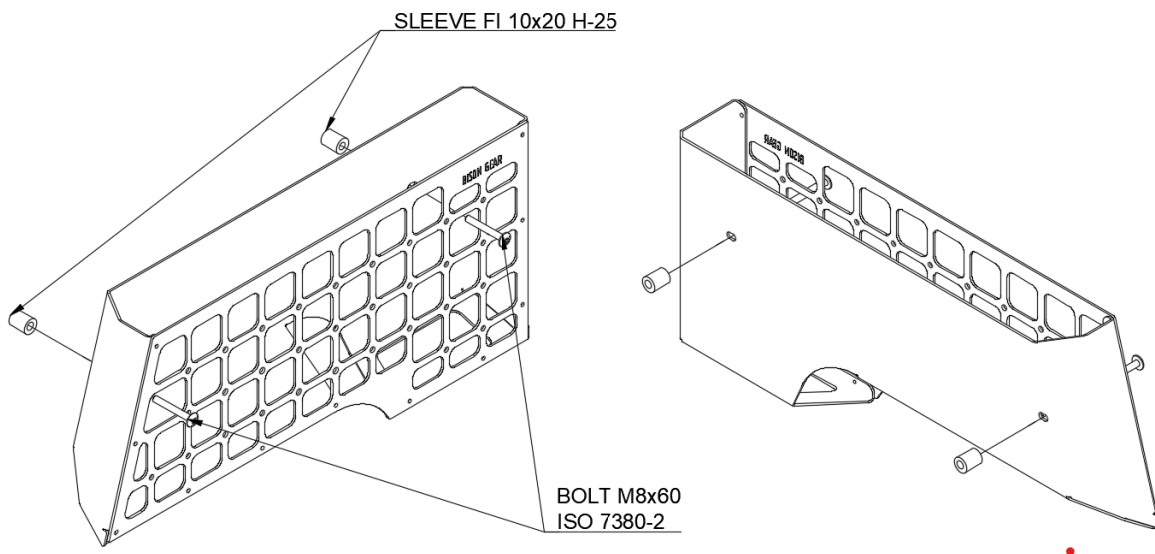



**BISON GEAR**

## Left Basket Diagram

